

DP 4613
FIFTH WALL MOUNTED BRUSH AND POT
INSTALLATION GUIDE

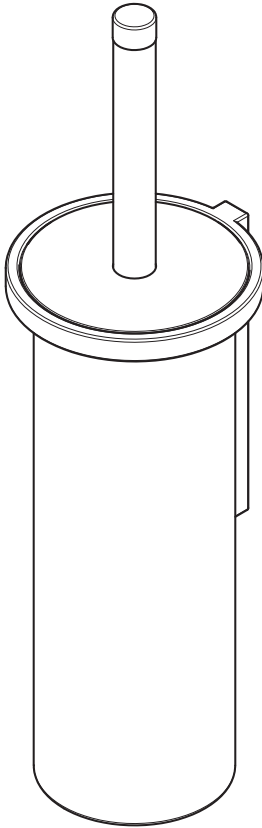

LEFROY BROOKS

DIMENSIONS

Shown without pot and brush fitted

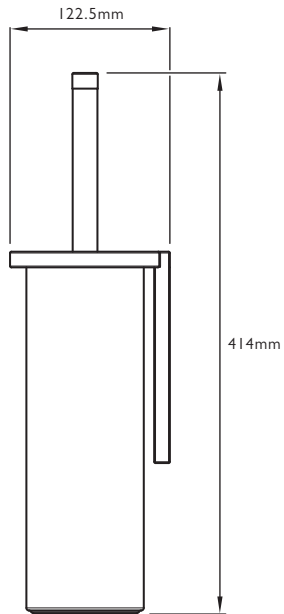
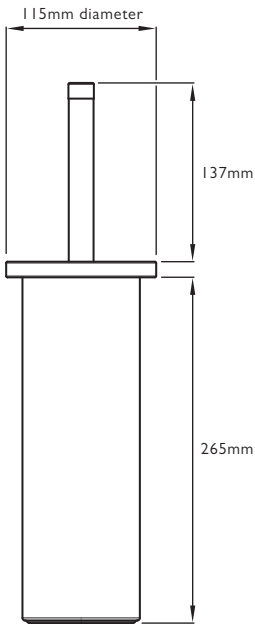
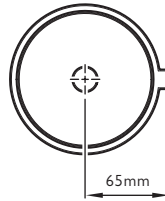
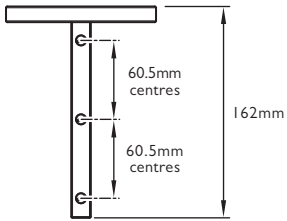

Not to scale

TOOLS REQUIRED

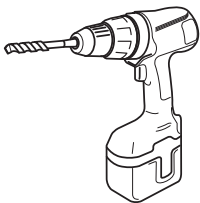

Powered drill with
Ø6mm drill bit

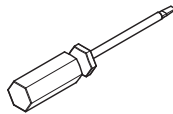

Flat blade screwdriver

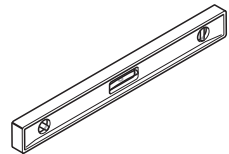

Spirit level

INSTALLATION

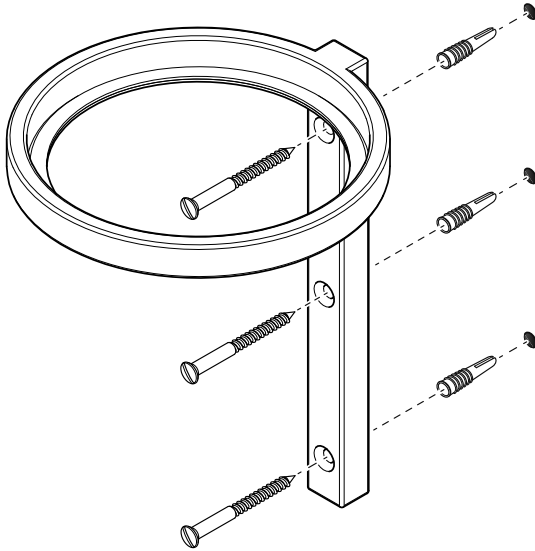

- 1 Mark the hole positions on the mounting surface. Use a spirit level to ensure the holes are vertically aligned.
- 2 Drill holes using a $\text{\O}6\text{mm}$ drill bit.
- 3 Insert the wall plugs into the holes then secure the pot and brush holder using the screws supplied.
- 4 Place the pot and brush into the holder.



CUSTOMER SUPPORT

+44 (0)1992 708 316

LEFROYBROOKS.CO.UK

Whilst every effort is made to ensure the accuracy of these, they are subject to change without notice as part of the company's product development process. The use of trademarks, product design and artwork is subject to licence or agreement with LBIP Ltd. The design registrations, trademark registrations and copyrights are protected by law and the use or reproduction outside the terms of an agreement is prohibited. The right to modify designs and dimensions is reserved. LBIP Ltd is a member of ACID (Anti Copying in Design).