

LB 2114 / EXT/LB 2114
STANDPIPES
INSTALLATION GUIDE

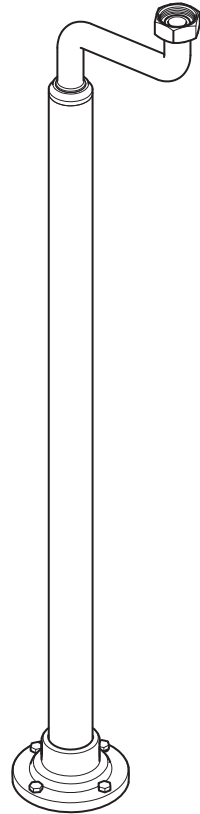
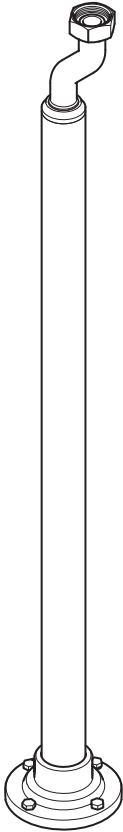

LEFROY BROOKS

DIMENSIONS

Taller standpipes can be specified at the point of order.

To reduce the height of the standpipes please see the 'installation – reducing height of standpipes' section.

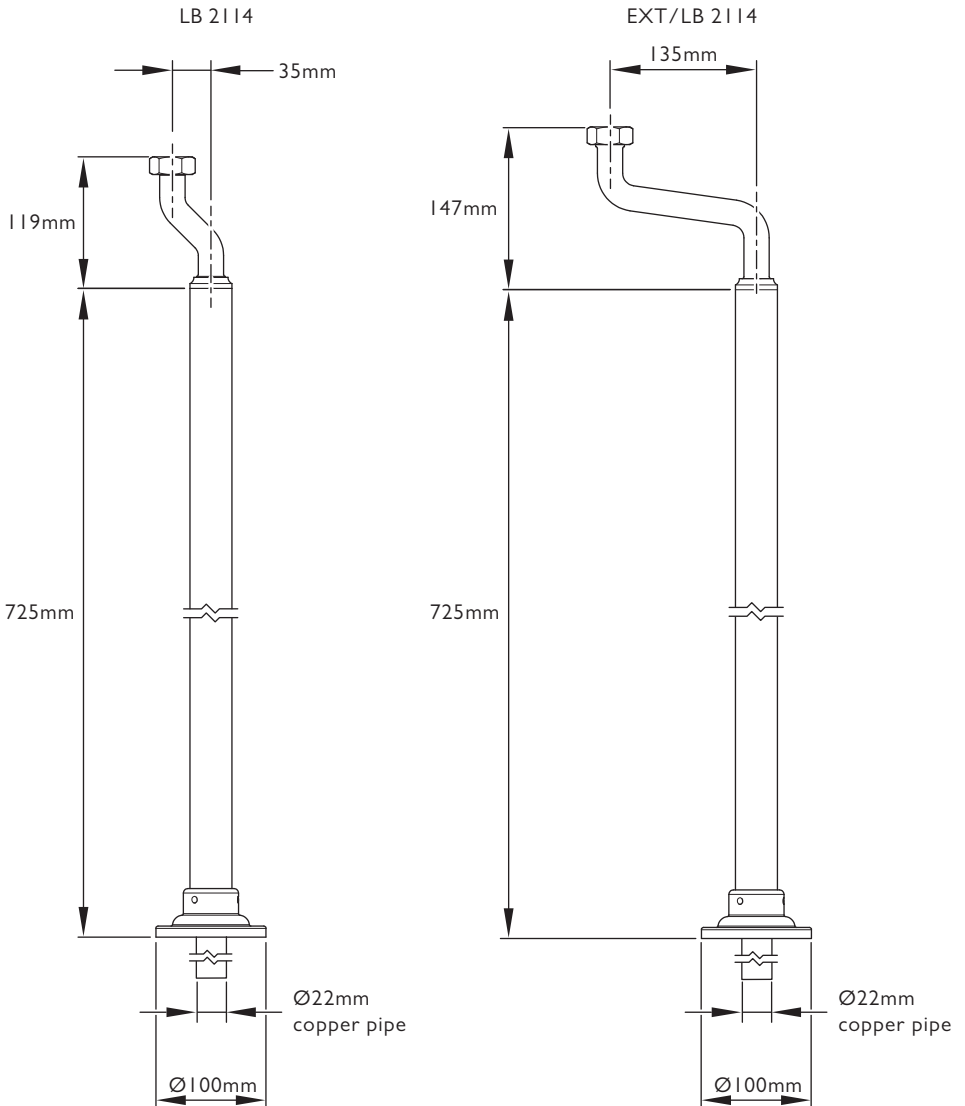

Not to scale

IMPORTANT INFORMATION

The LB 2114 and EXT/LB 2114 standpipes are NOT SUITABLE for use with the LA CHAPELLE and TEN TEN ranges. Please refer to retailer for these ranges.

Mounting surface

Standpipes are NOT suitable for mounting on solid floors. All connections should be installed underfloor.

Suitability

Manual and thermostatic Lefroy Brooks bath fillers/mixers are suitable for mounting on standpipes (please refer to retailer for La Chapelle and Ten Ten ranges).

Bath fillers with riser pipes and overhead showers are not suitable for standpipe mounting, unless positioned close to a wall and the installation includes an LBI786 adjustable riser support.

Standpipe variations and adjustments

Taller standpipes must be specified at the point of order.

Standpipes can be shortened on site – see 'installation – reducing height of standpipes' section.

Standpipes are available with extended cranked legs (EXT/LB 2114). This gives a reach of 135mm for free standing baths with extra wide roll tops. These are to be specified at the point of order as they cannot be retro fitted after installation.

Professional installation

We recommend that our products are fitted by a fully qualified professional plumber. They should be installed correctly and in accordance with all local water regulations and the system protected by non-return valves (not supplied). All products should be accessible for routine servicing.

Supply connections

The HOT water supply should be connected to the LEFT standpipe and COLD to the RIGHT standpipe as viewed from the front.

Water quality

In hard water areas, a suitable water treatment system should be provided to prevent limescale deposits (calcium deposits). Exterior surfaces should be gently wiped with a dry soft cloth after use to minimise water stains and limescale deposits.

Flushing system

It is most important to flush out all pipework thoroughly before connecting the mixer valve. Failure to do so is the single most common cause of cartridge failure.

Servicing

All serviceable parts are available to maintain your Lefroy Brooks product.

INSTALLATION – REDUCING HEIGHT OF STANDPIPES

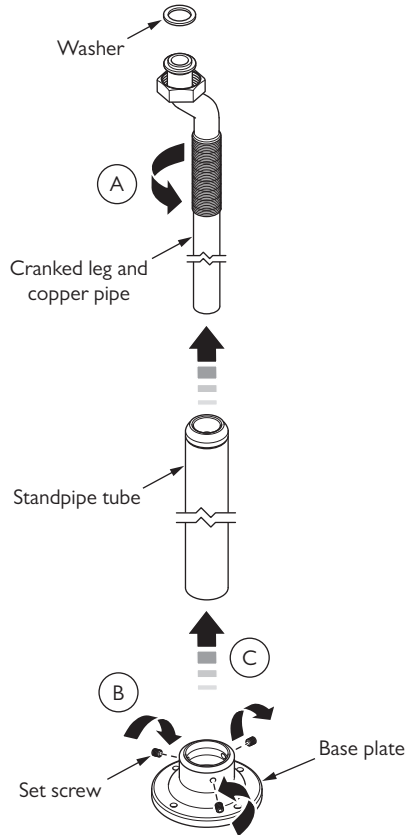
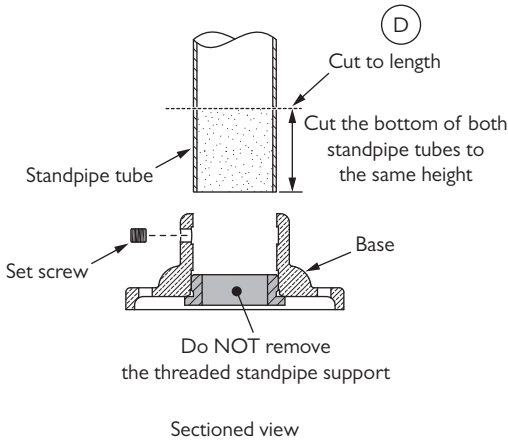

If required the standpipes can be shortened as follows:

- 1 The cranked leg and copper pipe that is concealed by the standpipe tube is a single unit. Unscrew and remove the cranked legs and copper pipes from both standpipe tubes (A).
- 2 Remove the three set screws from each standpipe base plate using a 3mm hexagonal key (B).
- 3 Separate both standpipe tubes from their base plates (C). Do NOT remove the threaded standpipe support from the base plate.
- 4 Accurately mark the bottom of both standpipe tubes ensuring that both marks are the same height (D).
- 5 Cut the bottom from both standpipe tubes and remove any sharp edges.
- 6 Fit the standpipe tubes into the base plates. Secure using the set screws removed previously.
- 7 Check that both standpipe heights are the same.
- 8 Screw the cranked leg and copper pipes into the standpipes.

INSTALLATION

Ø25mm holes at 180mm centres
(Centres can be reduced to 110mm minimum or increase to 250mm maximum –
please note that the cranked arms only face forward at 180mm centres)

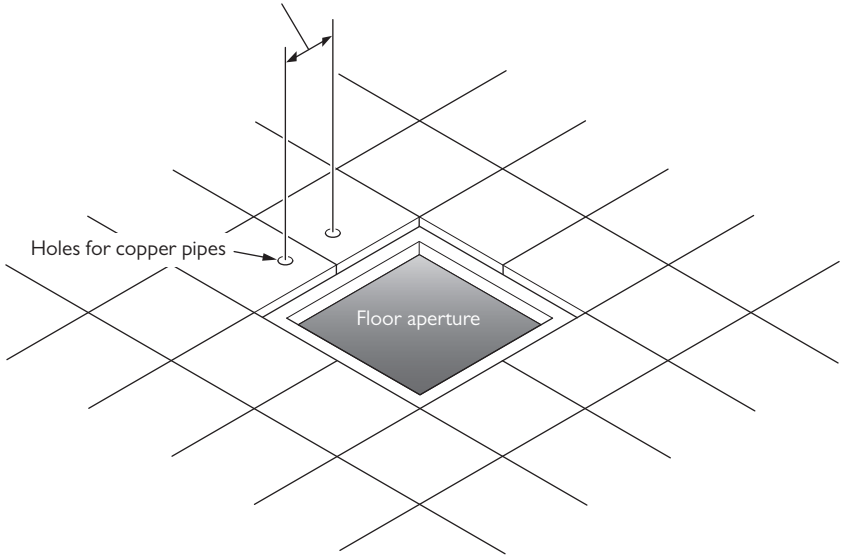

Considerations when choosing a location for standpipes:

- Does the spout of the mixer reach into the bath?
- Are there any joists, existing pipework or wiring immediately below the standpipes?
- Ø25mm holes for pipework should be made in the mounting surface prior to tiling.
- If the floor surface is to be covered or tiled prior to installation, ensure a space is left for the installation.
- Floor boards should be removed or cut to leave a suitable working aperture.
- Holes will have to be cut in the floor covering/tiles.

INSTALLATION

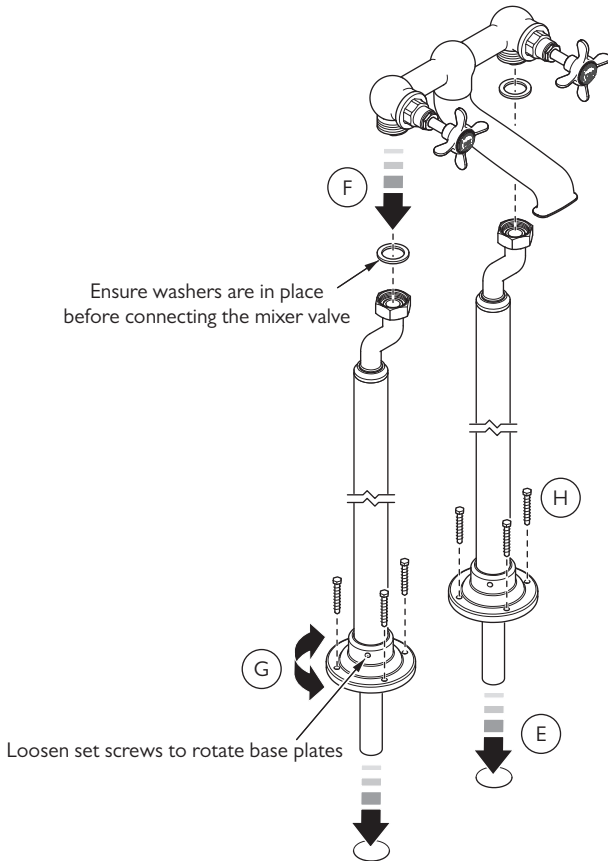

- 1 Place and support the standpipes in the required location (E).
- 2 Cut the copper pipes to the required length(s).
- 3 Connect the mixer to the standpipes (hand tight only) to ensure correct alignment and centre distances (F). Ensure that the rubber washers are in place before making the connection.
- 4 Once the standpipes and mixer are aligned correctly, ensure that the screw holes in the base plates are positioned as required. The three set screws in each base plate can be unscrewed allowing each base plate to be rotated (G). With the holes positioned as required, tighten the set screws.
- 5 Secure the base plates to the floor using the fixing screws (H) (Please note that specific installations may require special screws (not supplied)).
- 6 Using 22mm connections of your choice, proceed to finish the installation. Observe all safety requirements if using soldered joints.
- 7 Complete the pipework connections.
- 8 Remove the mixer to **FLUSH PIPEWORK**.
- 9 Securely fit the mixer to the standpipes.
- 10 Pressure test connections before sealing the floor aperture.

FAULT FINDING

Water leaks from the connection with the mixer valve.

- Connections not tight.
- Rubber washers are not fitted.
- Standpipes not at same height.



CONTRACT ENQUIRIES

+44 (0)1992 708 316

info@lefroybrooks.co.uk

CUSTOMER SERVICE, SPARES & TECHNICAL ENQUIRIES

+44 (0)1902 390 894

technical@lefroybrooks.co.uk

LEFROYBROOKS.CO.UK

Whilst every effort is made to ensure the accuracy of these, they are subject to change without notice as part of the company's product development process. The use of trademarks, product design and artwork is subject to licence or agreement with LBIP Ltd. The design registrations, trademark registrations and copyrights are protected by law and the use or reproduction outside the terms of an agreement is prohibited. The right to modify designs and dimensions is reserved. LBIP Ltd is a member of ACID (Anti Copying in Design). E&OE