



LEFROY BROOKS

IBROC HOUSE ESSEX ROAD
HODDESDON HERTS EN11 0QS UK
T: +44 (0)1992 708 316 F: +44 (0)1992 708 317

TT4975

TEN TEN DOUBLE PAPER HOLDER

DIMENSIONAL DATA SHEET

DATE: 05/09/16

REVISION: A

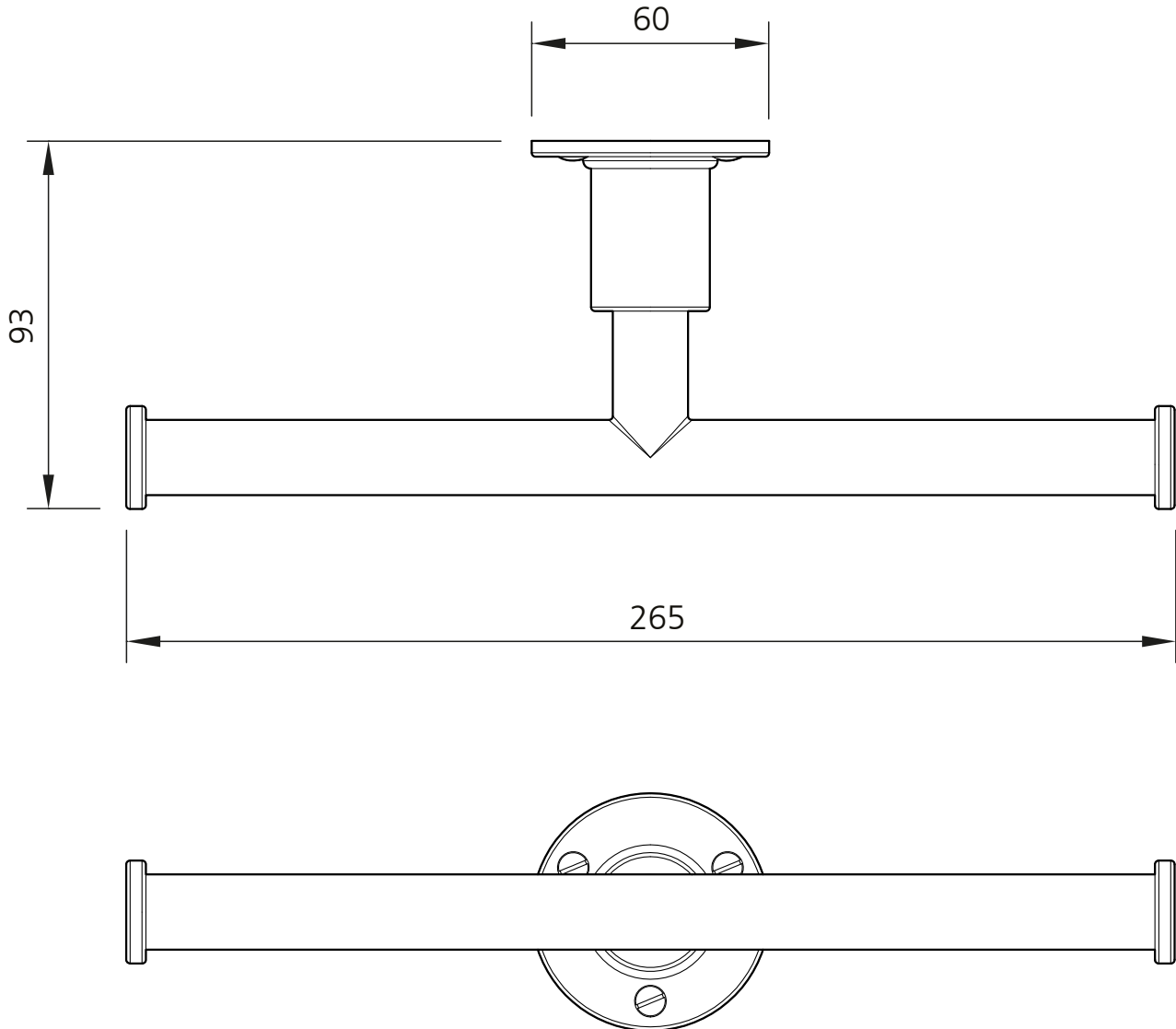

COPYRIGHT © LBIP LTD. ALL RIGHTS RESERVED

DIMENSIONS IN MILLIMETRES

WHILST EVERY EFFORT IS MADE TO ENSURE THE ACCURACY OF THESE DATA SHEETS THEY ARE SUBJECT TO CHANGE WITHOUT NOTICE AS PART OF THE COMPANY'S PRODUCT DEVELOPMENT PROCESS